

CG400 STOREFRONT WALL

CG400 / CS400 SYSTEM HIGHLIGHT

- 1 3/4" x 4" FRAMING FOR 1/4" GLASS
- CENTER-GLAZED STOREFRONT FRAMING
- SCREW SPLINE ASSEMBLY AND STACK INSTALLATION OPTION
- INTERIOR OR EXTERIOR GLAZING OPTION
- INTEGRATED DOOR FRAME
- OPTIONAL HEAD RECEPTORS, POST AND REINFORCEMENT

TYPICAL GLASS BITE = 5/16"

GLASS SIZE FORMULA = DLO + 5/8"

TAG DESCRIPTION

10	STANDARD HEAD DETAIL
10A	OPTIONAL HEAD W/RECEPTOR DETAIL
11	STANDARD INTERMEDIATE HORIZONTAL
12	STANDARD SILL DETAIL
20	STANDARD JAMB DETAIL
21	STANDARD VERTICAL MULLION-OPEN BACK
21A	OPTIONAL MULLION WITH REINFORCEMENT
21B	OPTIONAL CLOSED MULLION
30	4in JAMB MULLION
31	4in VERTICAL MULLION
32	4in INSIDE / OUTSIDE VERTICAL MULLION
40	TYPICAL DOOR JAMB DETAIL
41	TYPICAL DOOR HEADER DETAIL
50	STACK SILL DETAIL
51	STACK HEAD DETAIL



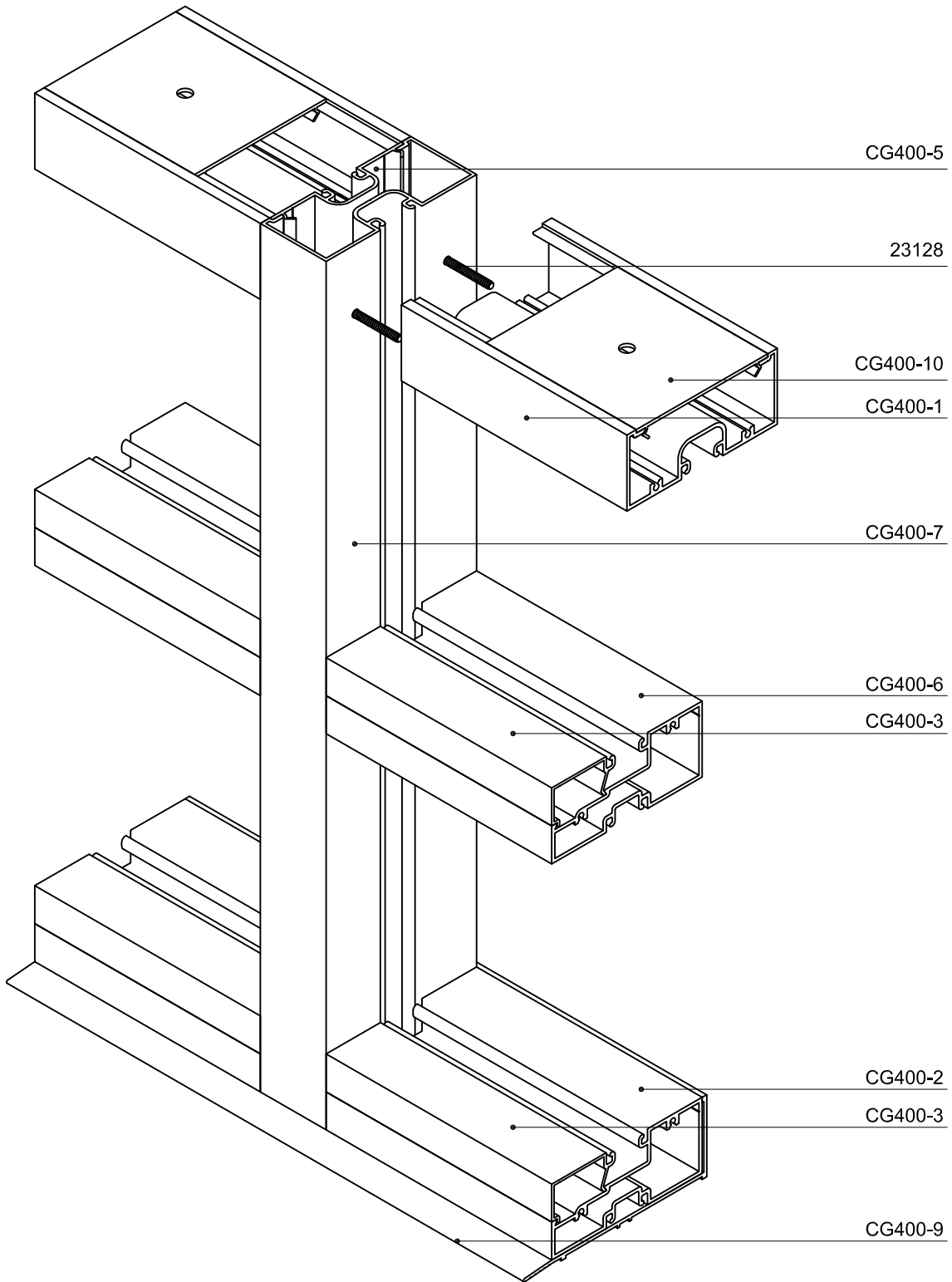

CG400 STOREFRONT SYSTEM



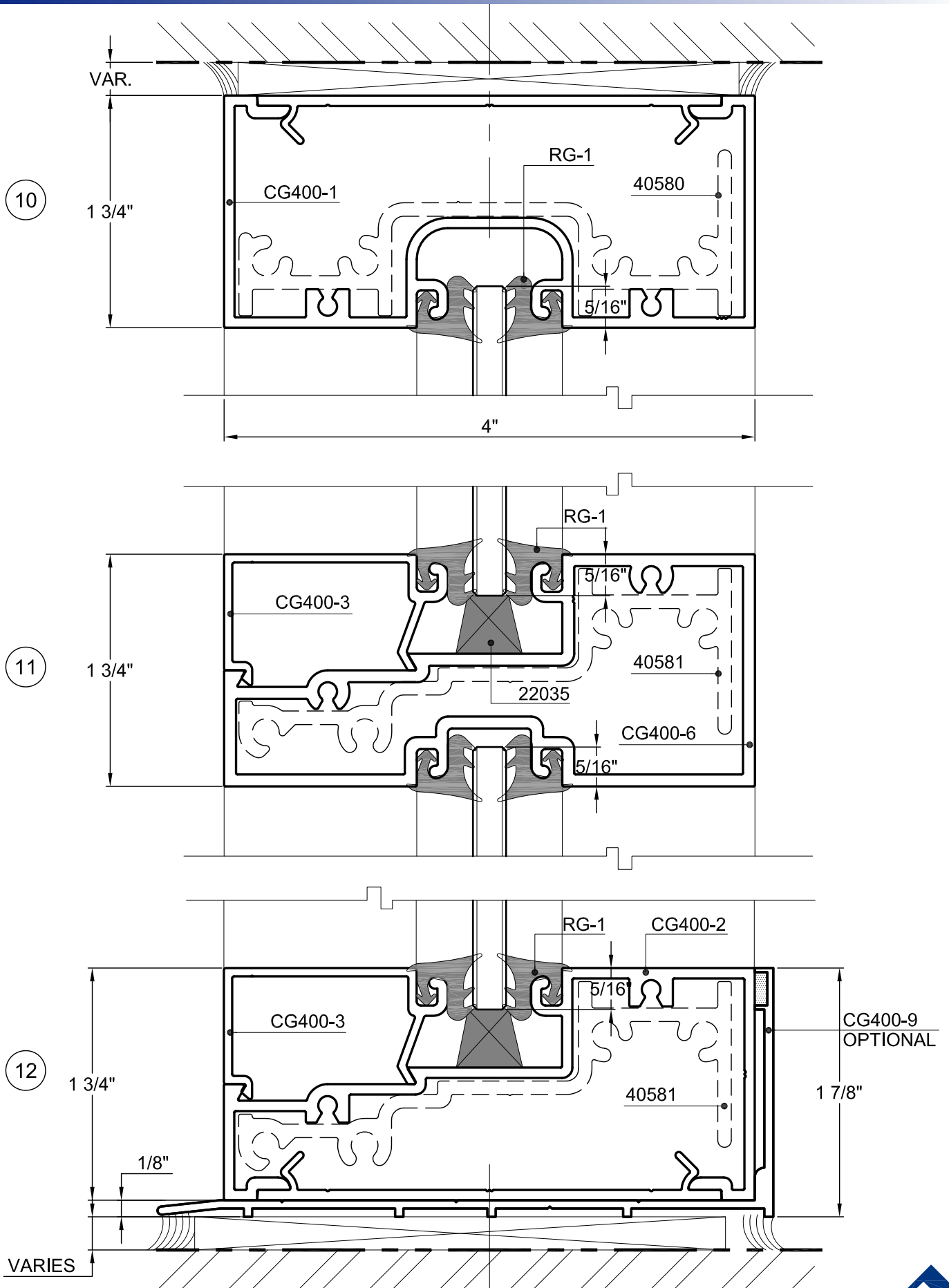

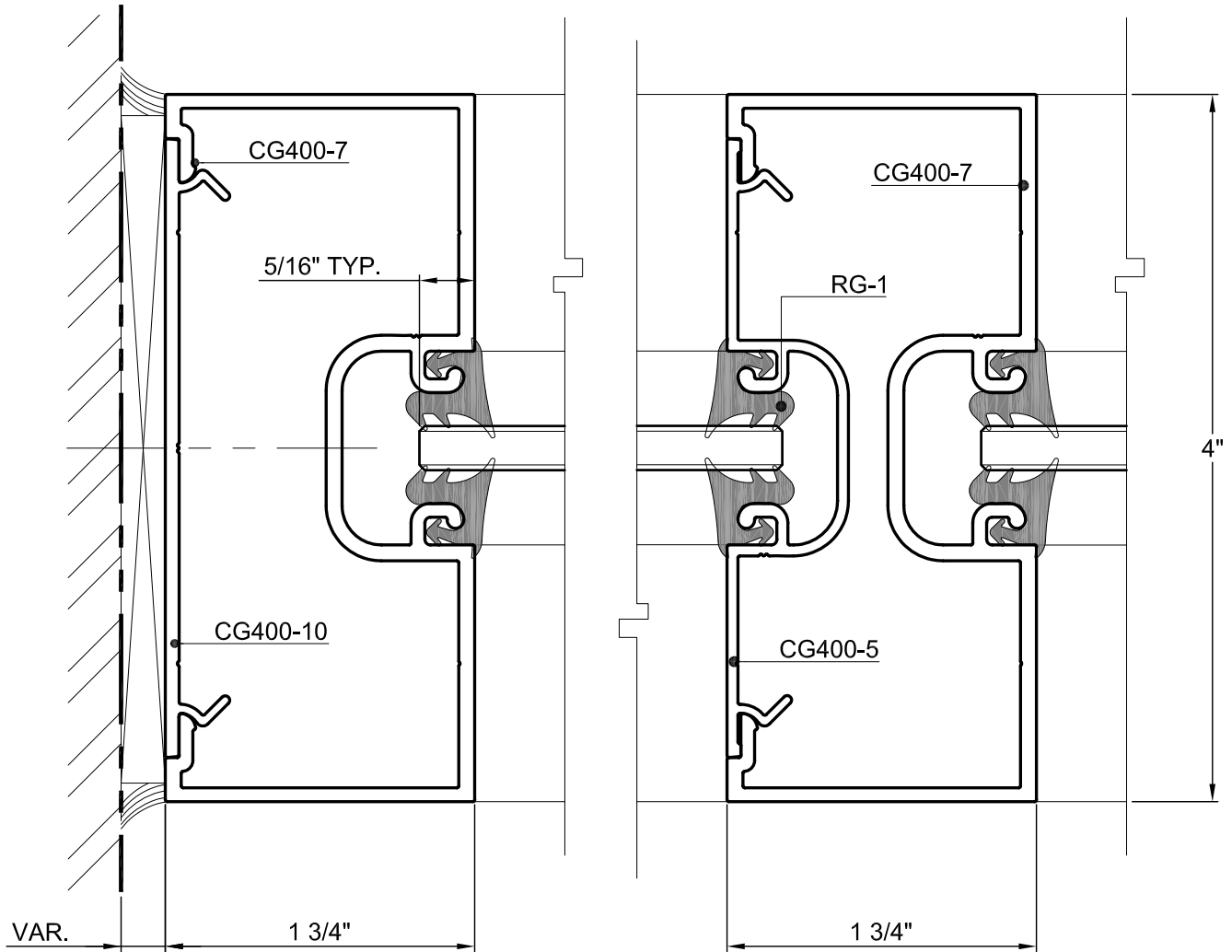

20

TYPICAL JAMB

21

TYPICAL INTERMEDIATE
MULLION



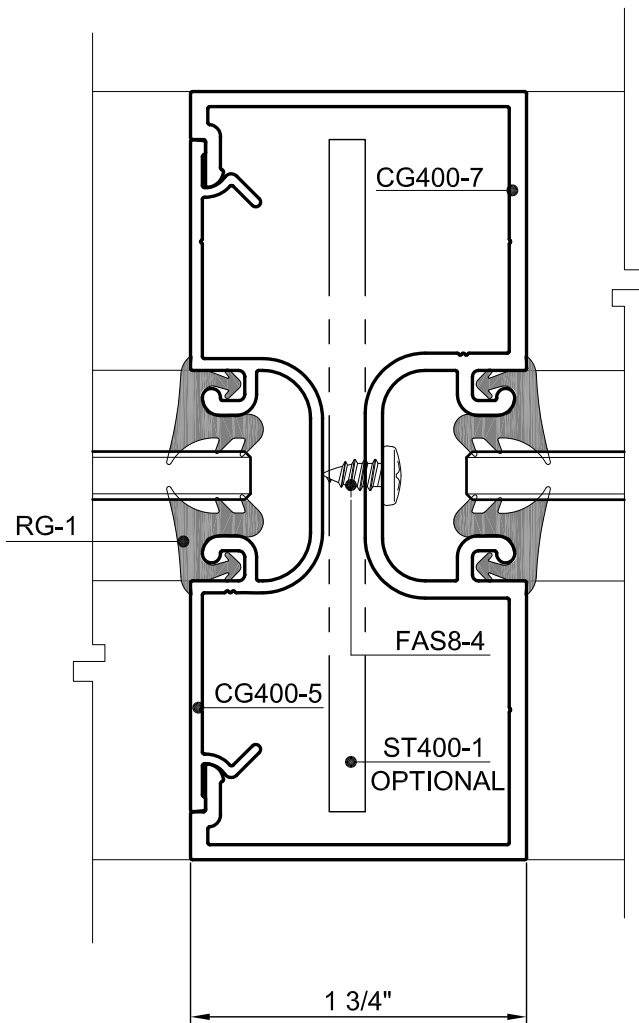

21A

MULLION WITH OPTIONAL
STEEL REINFORCEMENT

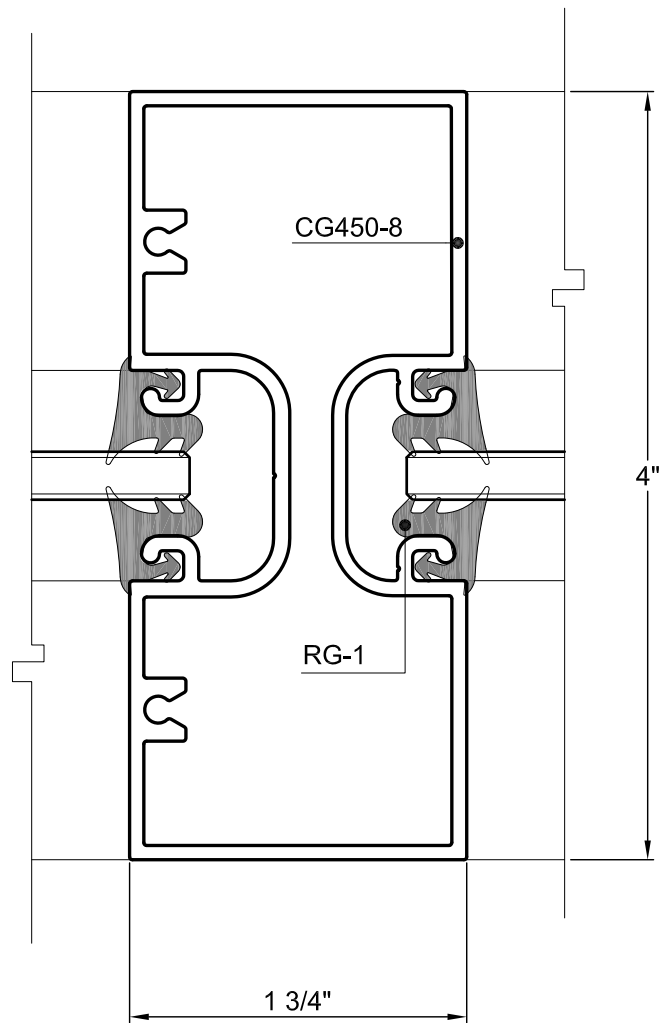

21B

OPTIONAL MULLION



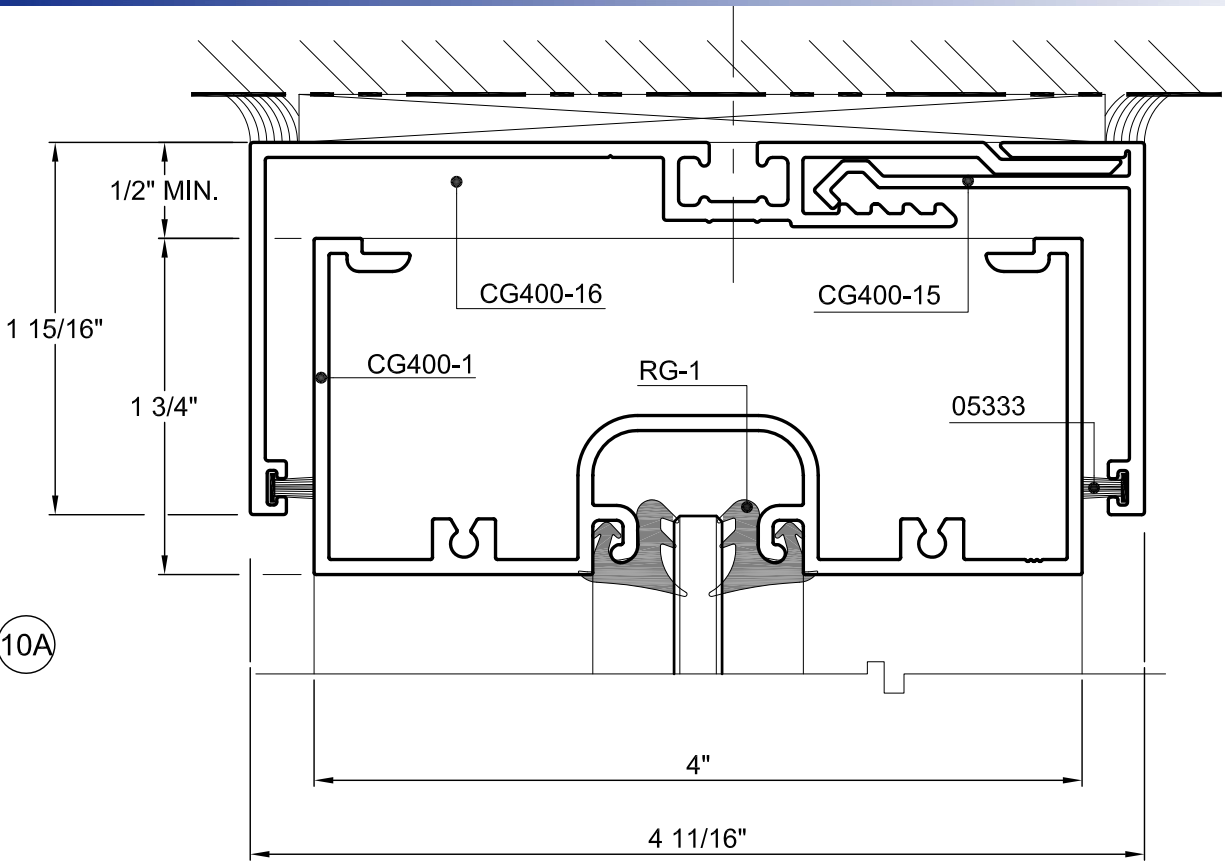

10A

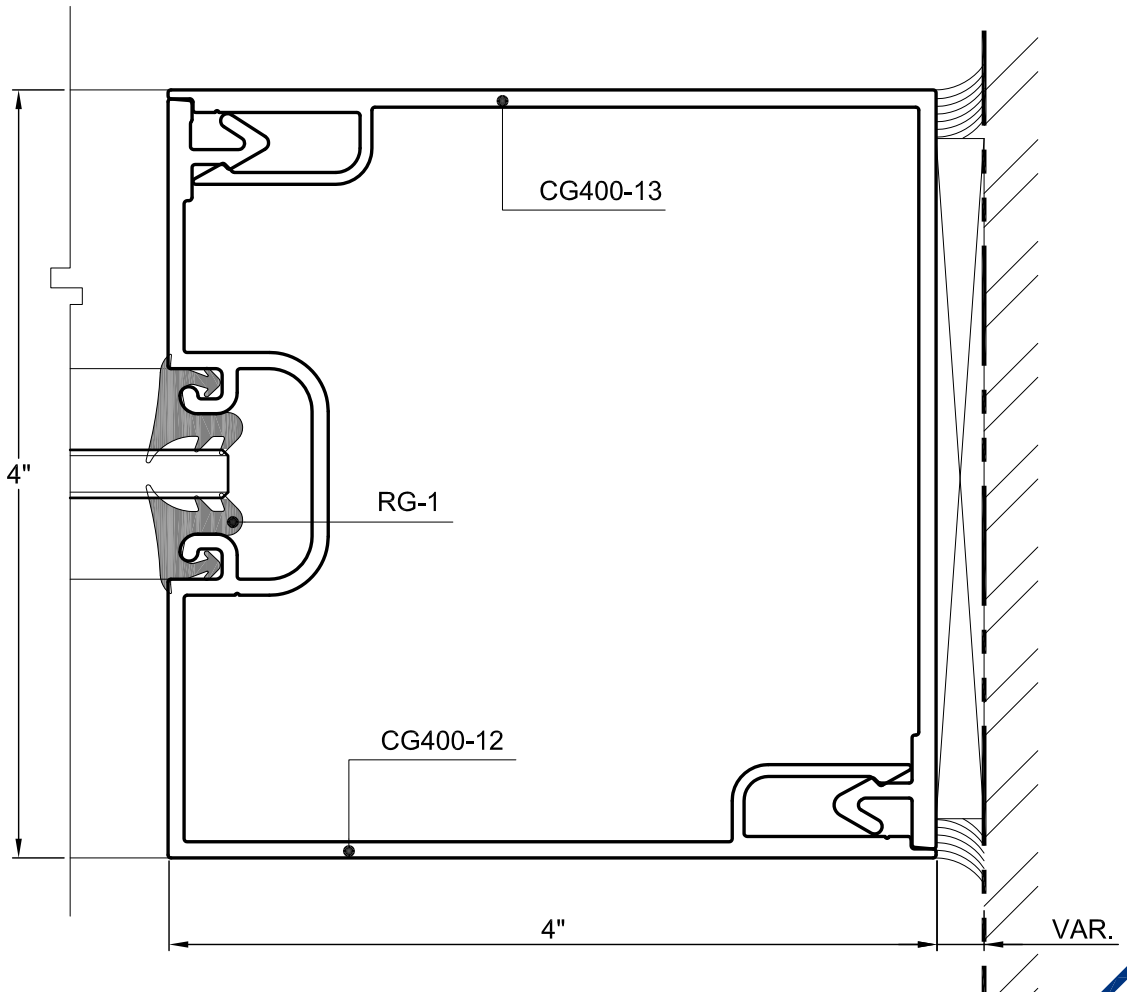

30



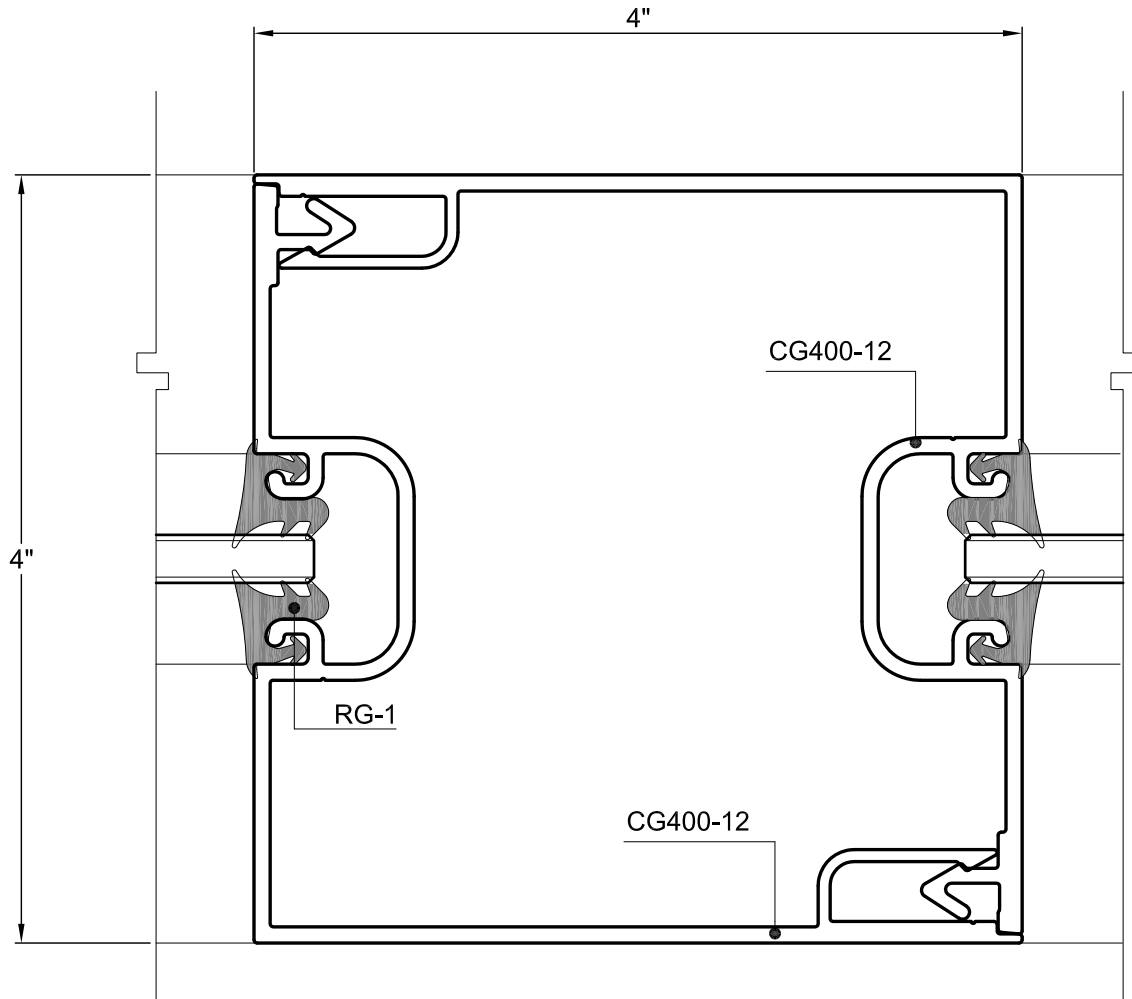

31 INTERMEDIATE WIDE MULLION



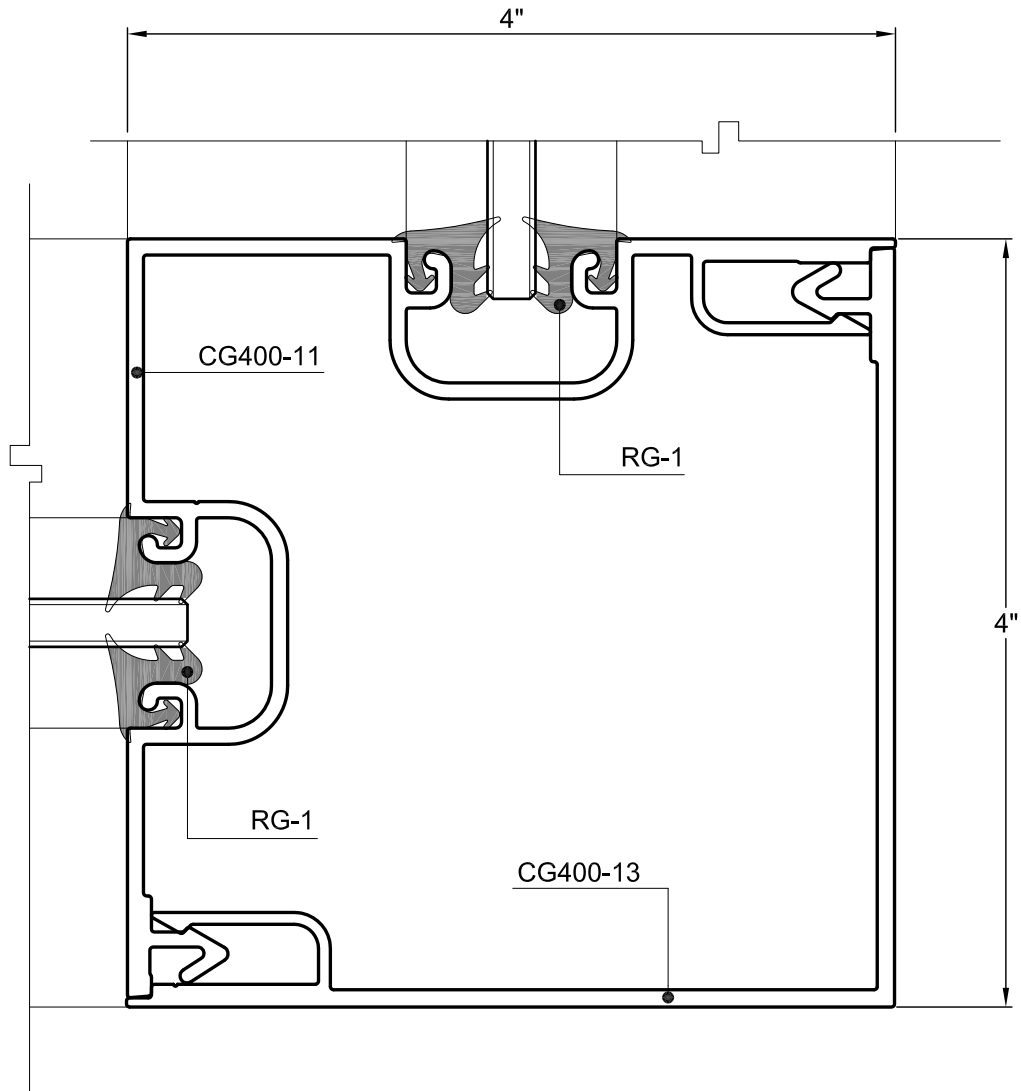

32 WIDE OUTSIDE CORNER



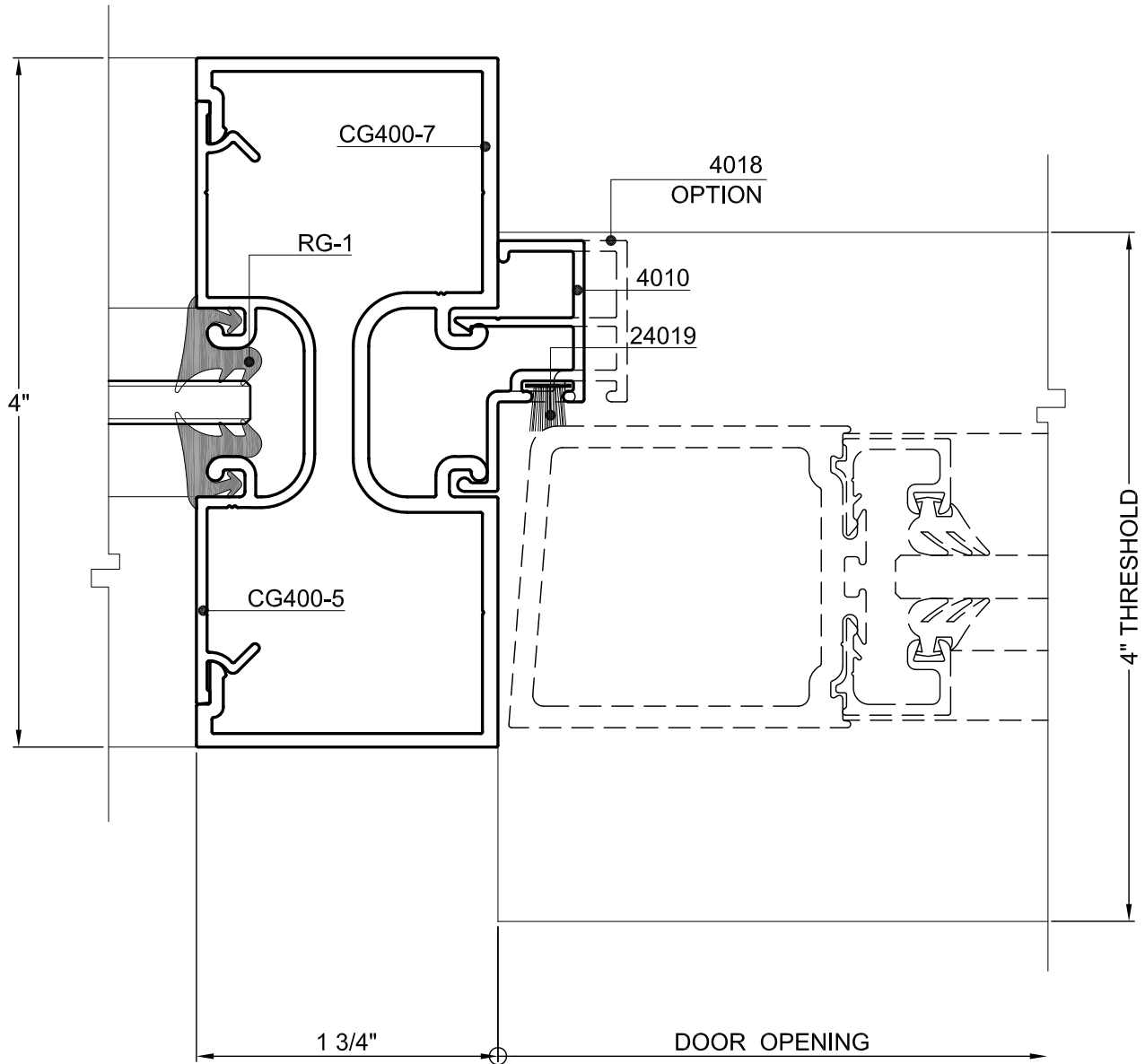

40 DOOR JAMB



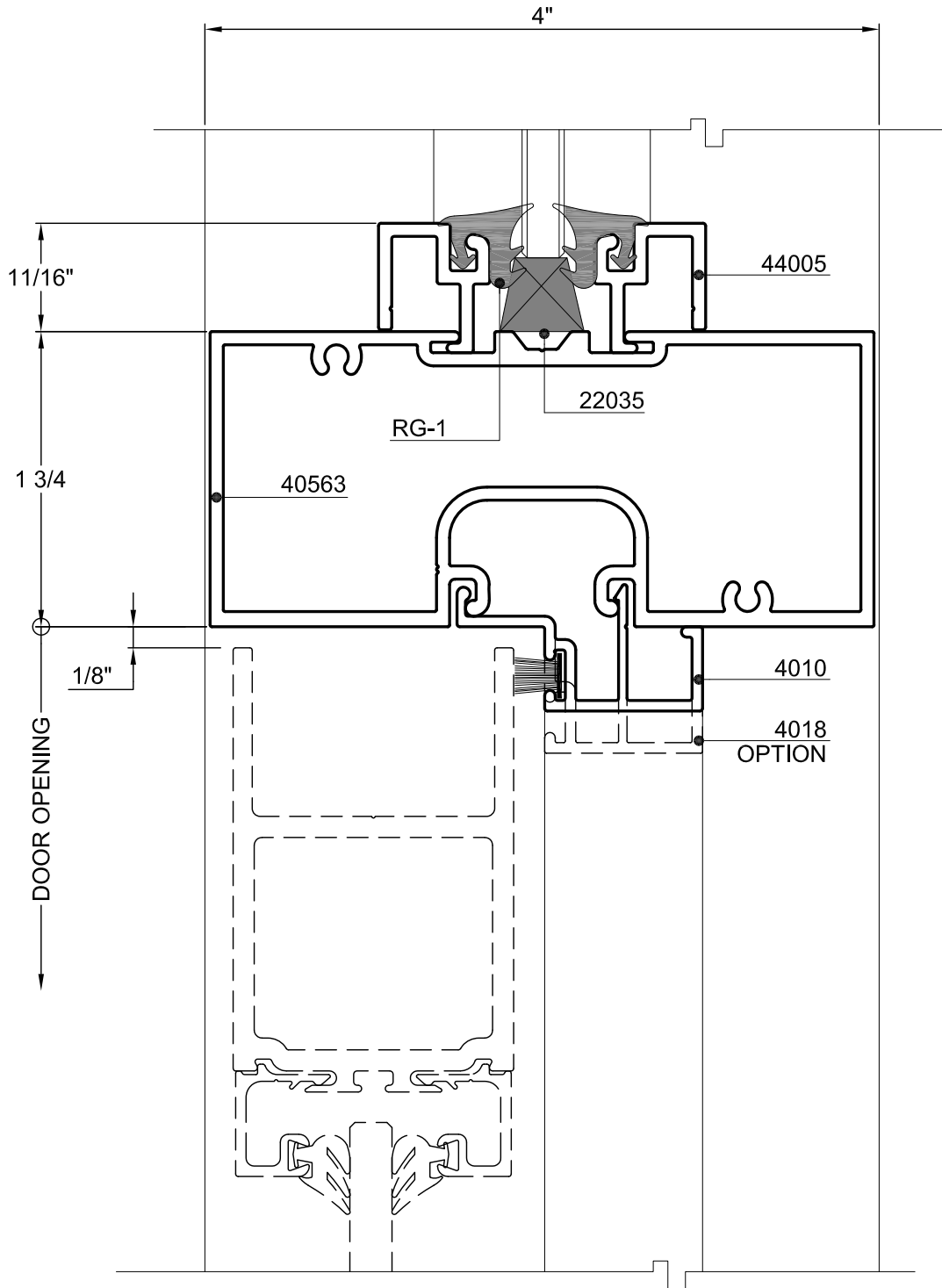







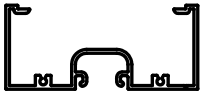
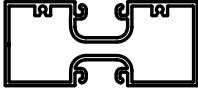

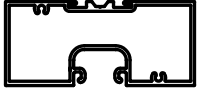
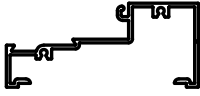





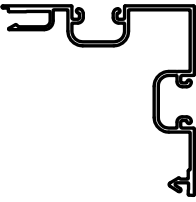

41 DOOR TRANSOM HEAD

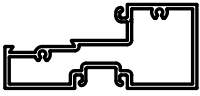
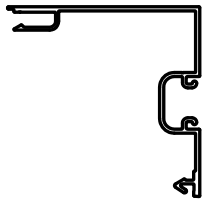

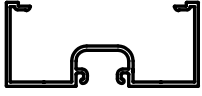
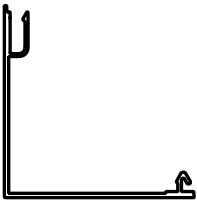
CG400 PARTS TABLE

			
CG400-1 HEAD/JAMB/VERTICAL MULLION	CG400-8 VERTICAL MULLION	CG400-14 FLUSH FILLER	40563 TRANSOM BAR
			
CG400-2 OPEN BACK SILL	CG400-9 SILL FLASHING	CG400-15 HEAD RECEPTOR SNAP-IN	10027 SNAP ON DOOR STOP 1/2" X 1 1/32"
			
CG400-3 GLASS STOP	CG400-10 INSERT FOR OPEN BACK FILLER	CG400-16 HEAD RECEPTOR BASIC MEMBER	40785 FACE
			
CG400-5 FILLER	CG400-11 90° CORNER POST	40784 BACK MEMBER FOR 1/4" & 3/8" GLAZING	40580 FLUSH GLAZED SILL / HORIZONTAL CLIP
			
CG400-6 INTERMEDIATE HORIZONTAL	CG400-12 180° SPLIT CORNER POST	40581 FLUSH GLAZED HEAD CLIP	RG-1 STANDARD GLAZING GASKET
			
CG400-7 OPEN BACK JAMB	CG400-13 SPLIT CORNER POST COVER	RG-2 LIGHT GLAZING GASKET	RG-5 DOOR STOP BULB GASKET

